

Service Manual

SM17 /F1N, /N1G, /S1G
/N1B, /U1B
Power amplifier

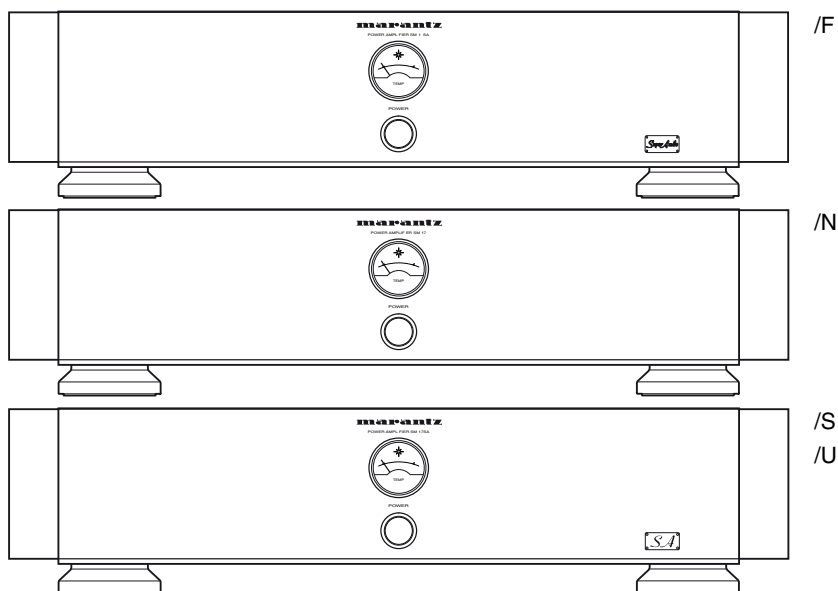

SM-17 / SM-17SA

TABLE OF CONTENTS

SECTION	PAGE
1. TECHNICAL SPECIFICATIONS	1
2. BLOCK DIAGRAM	2
3. TEST EQUIPMENT REQUIRED FOR SERVICING	2
4. SCHEMATIC DIAGRAM	3
5. PARTS LOCATION (Pattern Side)	5
6. EXPLODED VIEW AND PARTS LIST	7
7. IDLING CURRENT ADJUSTMENT	10
8. ELECTRICAL PARTS LIST	11

Please use this service manual with referring to the user guide (D.F.U.) without fail.

修理の際は、必ず取扱説明書を準備し操作方法を確認の上作業を行ってください。

marantz®

SM-17 / SM-17SA

314J855010 MIT
3120 785 22190
First Issue 1999.10

MARANTZ DESIGN AND SERVICE

Using superior design and selected high grade components, **MARANTZ** company has created the ultimate in stereo sound. Only original **MARANTZ** parts can insure that your **MARANTZ** product will continue to perform to the specifications for which it is famous.

Parts for your **MARANTZ** equipment are generally available to our National Marantz Subsidiary or Agent.

ORDERING PARTS :

Parts can be ordered either by mail or by Fax.. In both cases, the correct part number has to be specified.

The following information must be supplied to eliminate delays in processing your order :

1. Complete address
2. Complete part numbers and quantities required
3. Description of parts
4. Model number for which part is required
5. Way of shipment
6. Signature : any order form or Fax. must be signed, otherwise such part order will be considered as null and void.

USA

MARANTZ AMERICA, INC.
440 MEDINAH ROAD
ROSELLE, ILLINOIS 60172
USA
PHONE : 630 - 307 - 3100
FAX : 630 - 307 - 2687

EUROPE / TRADING

MARANTZ EUROPE B.V.
P.O.BOX 80002, BUILDING SFF2
5600 JB EINDHOVEN
THE NETHERLANDS
PHONE : +31 - 40 - 2732241
FAX : +31 - 40 - 2735578

BRAZIL

MARANTZ BRAZIL
CAIXA POSTAL 21462
CEP 04698-970
SAO PAULO, SP, BRAZIL
PHONE : 0800 - 123123(Discagem Direta Gratuita)
FAX : +55 11 534. 8988

PROFESSIONAL AMERICAS

SUPERSCOPE TECHNOLOGIES, INC.
MARANTZ PROFESSIONAL PRODUCTS
2640 WHITE OAK CIRCLE, SUITE A
AURORA, ILLINOIS 60504 USA
PHONE : 630 - 820 - 4800
FAX : 630 - 820 - 8103

CANADA

LENBROOK INDUSTRIES LIMITED
633 GRANITE COURT,
PICKERING, ONTARIO L1W 3K1
CANADA
PHONE : 905 - 831 - 6333
FAX : 905 - 831 - 6936

AUSTRALIA

JAMO AUSTRALIA PTY LTD
1 EXPO COURT, P.O. BOX 350
MT. WAVERLEY VIC 3149
AUSTRALIA
PHONE : +61 - 3 - 9543 - 1522
FAX : +61 - 3 - 9543 - 3677

THAILAND

MRZ STANDARD CO.,LTD
746 - 754 MAHACHAI ROAD.,
WANGBURAPAPIROM, PHRANAKORN,
BANGKOK, 10200 THAILAND
PHONE : +66 - 2 - 222 9181
FAX : +66 - 2 - 224 6795

SINGAPORE

WO KEE HONG (S) PTE LTD
WO KEE HONG CENTRE
NO.23, LORONG 8, TOA PAYOH
SINGAPORE 319257
PHONE : +65 2544555
FAX : +65 2502213

TAIWAN

PAI-YUING CO., LTD.
6 TH FL NO, 148 SUNG KIANG ROAD,
TAIPEI, 10429, TAIWAN R.O.C.
PHONE : +886 - 2 - 25221304
FAX : +886 - 2 - 25630415

MALAYSIA

WO KEE HONG ELECTRONICS SDN. BHD.
SUITE 8.1, LEVEL 8, MENARA GENESIS,
NO. 33, JALAN SULTAN ISMAIL,
50250 KUALA LUMPUR, MALAYSIA
PHONE : +60 3 - 2457677
FAX : +60 3 - 2458180

JAPAN Technical

MARANTZ JAPAN, INC.
35- 1, 7- CHOME, SAGAMIONO
SAGAMIHARA - SHI, KANAGAWA
JAPAN 228-8505
PHONE : +81 42 748 1013
FAX : +81 42 741 9190

日本マランツ株式会社

本 社 〒228-8505
神奈川県相模原市相模大野7-35-1
営業本部 〒150-0022
東京都渋谷区恵比寿南1-11-9

KOREA

MK ENTERPRISES LTD.
ROOM 604/605, ELECTRO-OFFICETEL, 16-58,
3GA, HANGANG-RO, YONGSAN-KU, SEOUL
KOREA
PHONE : +822 - 3232 - 155
FAX : +822 - 3232 - 154

SHOCK, FIRE HAZARD SERVICE TEST :

CAUTION : After servicing this appliance and prior to returning to customer, measure the resistance between either primary AC cord connector pins (with unit NOT connected to AC mains and its Power switch ON), and the face or Front Panel of product and controls and chassis bottom.

Any resistance measurement less than 1 Megohms should cause unit to be repaired or corrected before AC power is applied, and verified before it is return to the user/customer.

Ref. UL Standard No. 1492.

In case of difficulties, do not hesitate to contact the Technical Department at above mentioned address.

1. TECHNICAL SPECIFICATIONS

Rated power output (20 Hz to 20 kHz, 2CH simultaneous drive)	60 W x 2 (8 Ω load)
	80 W x 2 (6 Ω load)
	100 W x 2 (4 Ω load)
(20 Hz to 20 kHz, BTL drive)	200 W x 1 (8 Ω load)
Total harmonic distortion (20 Hz to 20 kHz, 2CH drive, 8 Ω load)	0.01 %
Cross-modulation distortion (SMPTE)	0.01 %
Output bandwidth (8 Ω load, 0.04 %)	10 Hz to 50 kHz
Frequency response (CD, SOURCE DIRECT)	5 Hz to 100 kHz, +0/-1 dB
Damping factor (8 Ω load, 20 Hz to 20 kHz)	100
Input sensitivity/input impedance	
MAIN IN	1.6 V/22 kΩ
S/N (IHF A network, input shorted)	76 dB
Supply voltage	
F version	100 V AC, 50/60 Hz
/N1, /S1 version	230 V AC, 50 Hz
/U1 version	120 V AC, 60 Hz
Power consumption	180 W
Dimensions (Maximum)	
Width	458 mm
Height	110 mm
Depth	407 mm
Weight	15.5 kg
Accessories	

Design and specifications are subject to change without notice.

2. BLOCK DIAGRAM

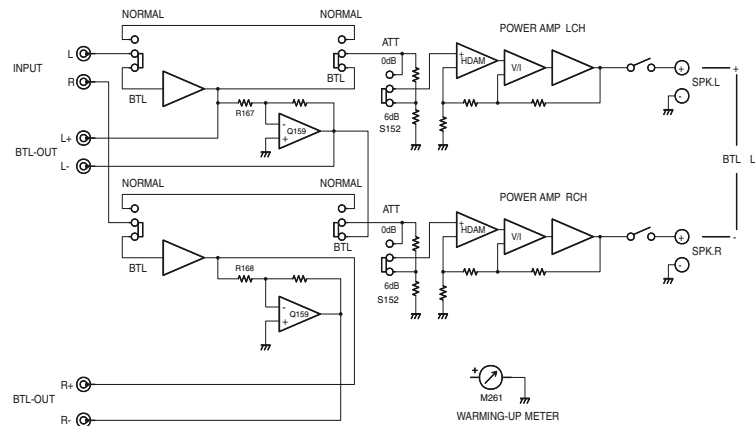

3. TEST EQUIPMENT REQUIRED FOR SERVICING

Item 項目	Use 使用方法
Distortion Analyzer 歪率計	Distortion measurements 歪の測定
Audio Oscillator 信号発生器	Sinewave and squarewave signal source 正弦波及び矩形波の信号源
AC VTVM 交流電圧計	Voltage measurements (AC) 交流電圧の測定
Oscilloscope オシロスコープ	Waveform analysis and trouble shooting and ASO alignment 波計分極、トラブルシューティング及びASOの調整
DC VTVM 直流電圧計	Voltage measurements (DC) 直流電圧の測定
AC Wattmeter 交流ワットメーター	Monitors primary power to amplifier アンプの一次側消費電力のモニター
Line Voltmeter 電源電圧計	Monitors potential of primary power to amplifier アンプの一次側消費電圧のモニター
Variable Autotransformer スライダック	Adjust level of primary power to amplifier アンプの一次側電圧の調整
Circuit Tester テスター	Trouble shooting トラブルシューティング
Shorting Plug ショート用プラグ	Shorts amplifier input to eliminate noise pickup 雑音を拾わないようにアンプ入力を短絡する

4. SCHEMATIC DIAGRAM

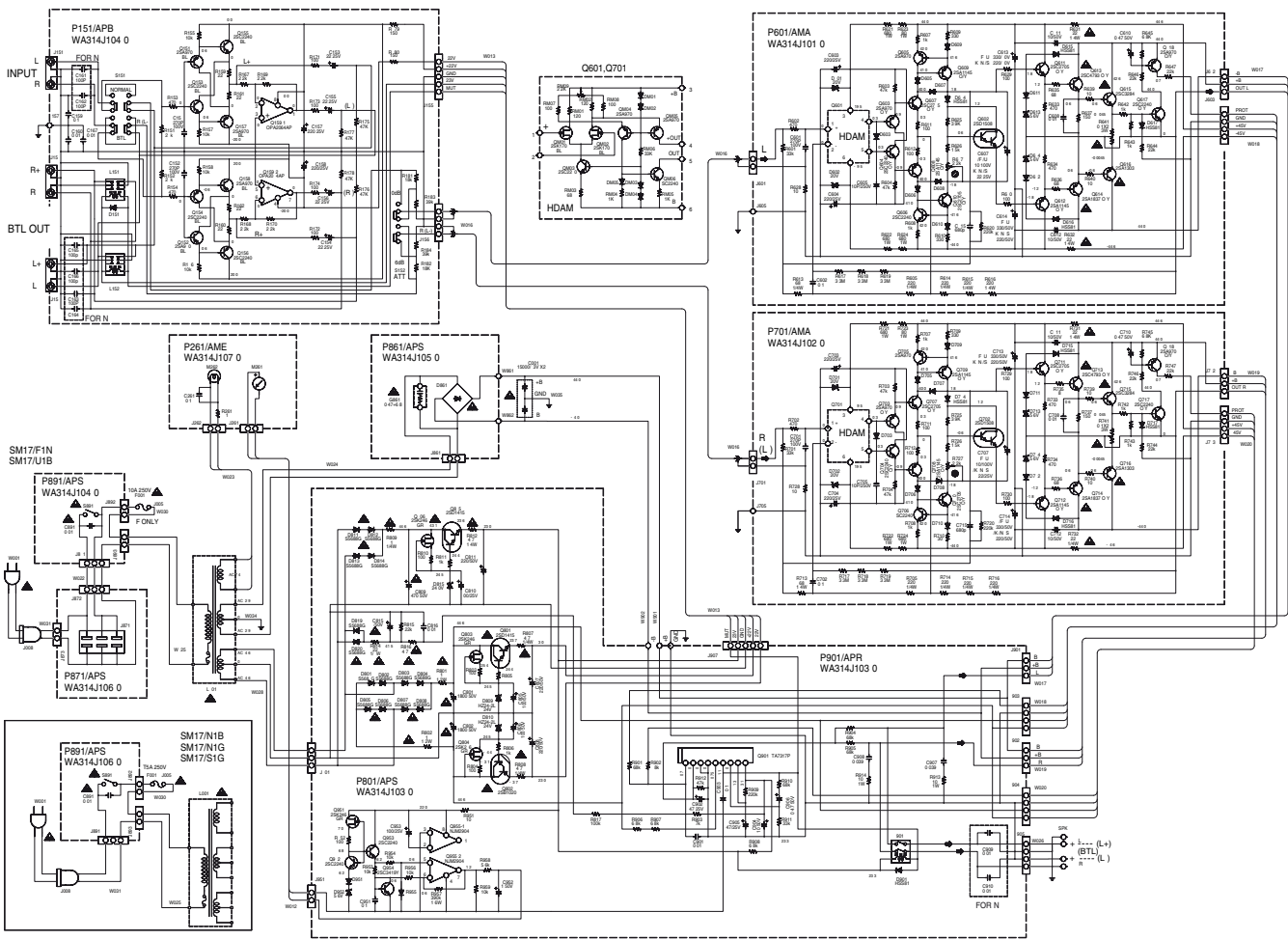

5. PARTS LOCATION (Pattern Side)

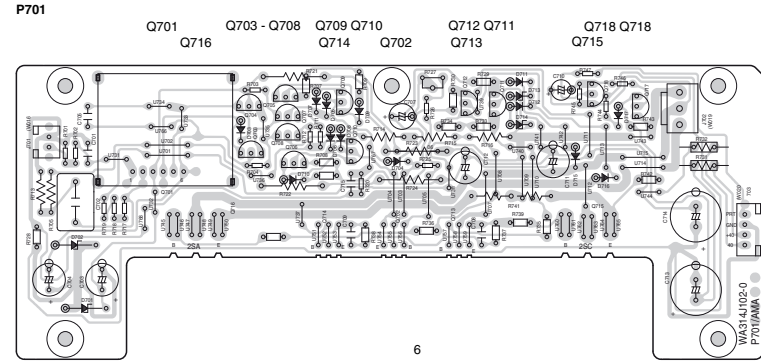
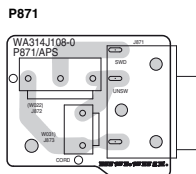
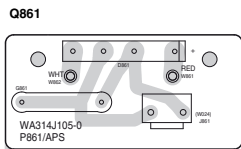
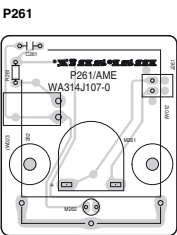
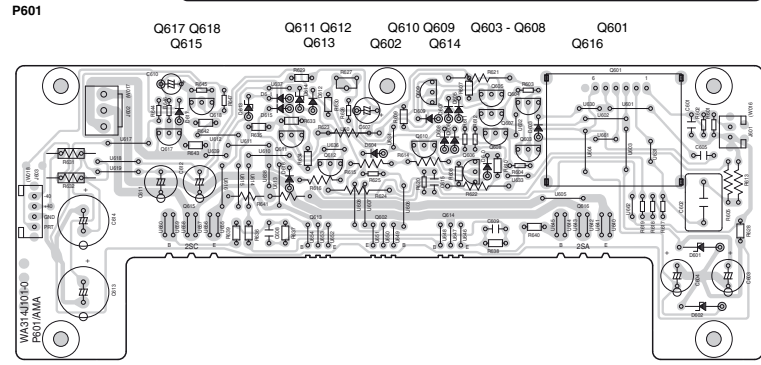
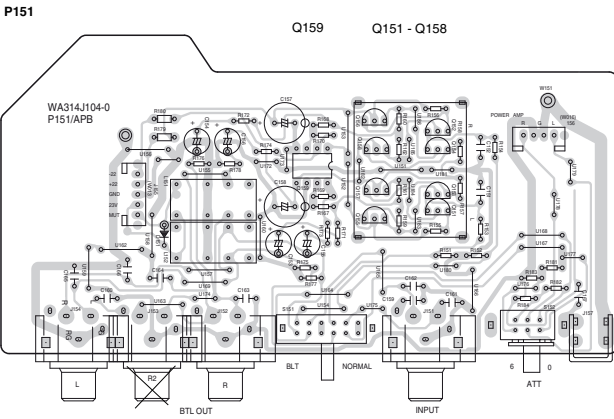
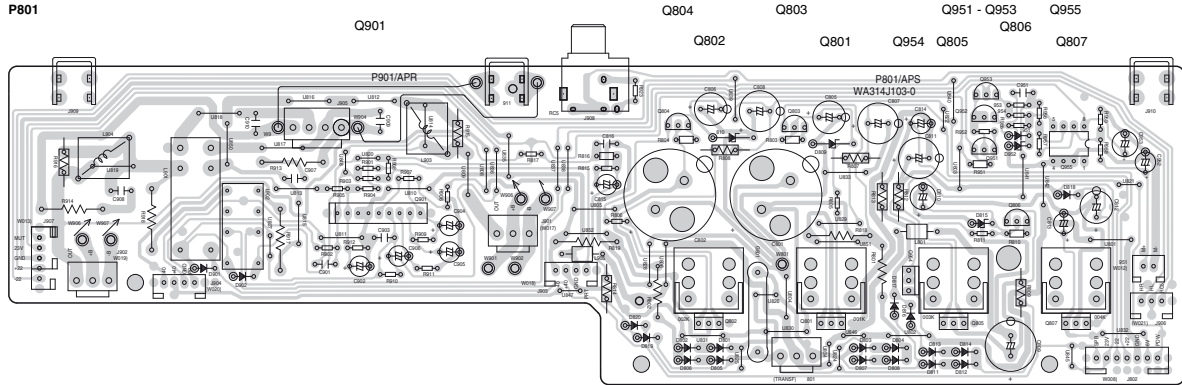
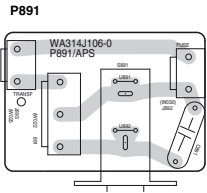

6. EXPLODED VIEW AND PARTS LIST

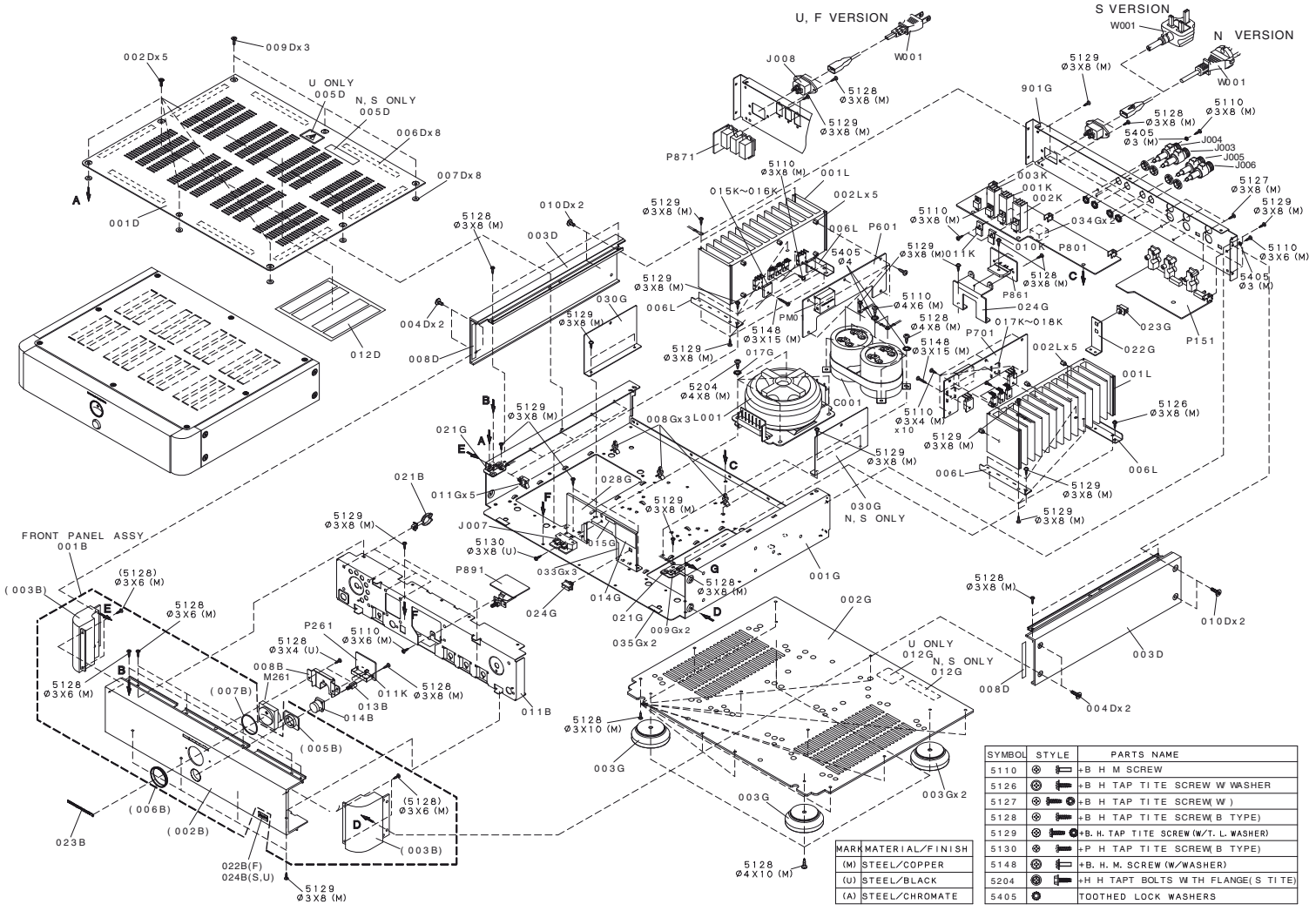

SYMBOL	STYLE	PARTS NAME
5110		B H M SCREW
5126		B H TAP TITE SCREW W WASHER
5127		B H TAP TITE SCREW (W)
5128		B H TAP TITE SCREW (B TYPE)
5129		B. H. TAP TITE SCREW (W/T. L. WASHER)
5130		P H TAP TITE SCREW (B TYPE)
5148		B. H. M. SCREW (W/WASHER)
5204		H H TAPT BOLTS W TH FLANGE(S TITE)
5405		TOOTHED LOCK WASHERS

MARK	MATERIAL/FINISH
(M)	STEEL/COPPER
(U)	STEEL/BLACK
(A)	STEEL/CHROMATE

POS. NO	VERS. COLOR	PART NO. (FOR PCS)	DESCRIPTION	PART NO. (MJI)	POS. NO	VERS. COLOR	PART NO. (FOR PCS)	DESCRIPTION	PART NO. (MJI)
001B	/F1N		FRONT PANEL ASSY SM-17SA	314J248520					
001B	/N1G	9965 000 01840	GOLD HAIR FRONT PANEL ASSY SM-17	314J248510	001T	/F		PACKING	
001B	/N1B	9965 000 01835	GOLD BLAST FRONT PANEL ASSY SM-17	314J248500	001T	/N	9965 000 01591	USER GUIDE	314J851110
001B	/S1G		BLACK BLAST FRONT PANEL ASSY SM-17SA	314J248540	001T	/S		USER GUIDE	314J851310
001B	/U1B		GOLD BLAST FRONT PANEL ASSY SM-17SA	314J248530	001T	/U		USER GUIDE	314J851350
003B	GOLD	4822 426 10497	BLACK BLAST ESCUTCHEON GOLD	269J063110				USER GUIDE	314J851250
003B	BLACK	4822 426 10496	ESCUTCHEON BLACK	269J063010					
013B		4822 404 21012	JOINT LINK FOR POWER	025J125010					
014B	/GOLD	4822 410 11276	BUTTON POWER GOLD	176J270150					
014B	BLACK	4822 410 11275	BUTTON POWER BLACK	176J270050					
022B	/F		BADGE FOR SUPER AUDIO	318J251010					
023B	GOLD	9965 000 01554	NEW MARANTZ BADGE GL	313J251110					
023B	BLACK	9965 000 01553	NEW MARANTZ BADGE BL	313J251010					
024B	/S, /U		S A BADGE	318J251020					
001D	GOLD	4822 442 01018	LID TOP GOLD	269J257110					
001D	BLACK	4822 442 01017	LID TOP BLACK	269J257010					
002D	GOLD	4822 502 14425	SCREW FOR TOP LID GOLD	323S010020					
002D	BLACK	4822 502 21693	SCREW FOR TOP LID BLACK	323S010030					
003D	GOLD	4822 426 10499	SIDE PANEL GOLD	269J249110					
003D	BLACK	4822 426 10498	SIDE PANEL BLACK	269J249010					
004D	GOLD	4822 502 14425	SCREW FOR SIDE PANEL FRONT GOLD	323S010020					
004D	BLACK	4822 502 21693	SCREW FOR SIDE PANEL FRONT BLACK	323S010030					
009D	GOLD	4822 502 14462	SCREW FOR TOP LID REAR PANEL	318K010020					
009D	BLACK	4822 502 14461	SCREW FOR TOP LID REAR BLACK	318K010030					
010D	GOLD	4822 502 14462	SCREW FOR SIDE PANEL REAR GOLD	318K010020					
010D	BLACK	4822 502 14461	SCREW FOR SIDE PANEL REAR BLACK	318K010030					
002G			LID BOTTOM	313J257020					
003G		4822 462 42134	LEG	291K057010					
▲ C001		9965 000 01557	ELECT 15000µF 63V x 2 FOR AUDIO	EI15906350					
▲ F001	/F		FUSE 10A 250V MITI GRU	FS11000570					
▲ F001	/N,/S	4822 070 35002	FUSE 5A 250V BS LISTED	FS10500850					
▲ F001	/U		FUSE 10A 250V	FS11000530					
J003		4822 265 11424	TERMINAL SPK. RED	YT01010360					
J004		4822 265 11425	TERMINAL SPK. WHT	YT01010370					
J005		4822 265 11424	TERMINAL SPK. RED	YT01010360					
J006		4822 265 11425	TERMINAL SPK. WHT	YT01010370					
J007	/F,/U		JACK FUSE HOLDER 10A 250V 31.8MM	YJ08000600					
J007	/N,/S	4822 267 31818	JACK FUSE HOLDER H201 20MM	YJ08000610					
▲ J008		4822 265 11399	JACK AC INLET SOT-16C	YJ04002360					
▲ L001	/F		MAINS TRANSFORMER	TS42002120					
▲ L001	/N,/S	9965 000 01558	MAINS TRANSFORMER	TS42002130					
▲ L001	/U		MAINS TRANSFORMER	TS42002150					
▲ W001	/F		MAINS CORD MITY DC-302-J 12A	ZC01802080					
▲ W001	/N	4822 321 11439	MAINS CORD 2P10A 250V CLASS2	ZC01803080				NOT STANDARD SPARE PARTS	
▲ W001	/S		MAINS CORD	ZC01804070	001S	/F,/U		PACKING CASE SM-17SA	314J801010
▲ W001	/U		MAINS CORD UL/CSA 10A 125V	ZC01803100	002S			CUSHION FOR LEFT	314J809010
					003S			CUSHION FOR RIGHT	314J809020

6. DC OFFSET VOLTAGE ALIGNMENT

1. Before switching the mains switch. Turn down the master volume to the minimum position and set the balance volume and tone volumes at the center positions. Set variable resistors R627(on the PCB P601:L ch) and R727(on the PCB P701:R ch) fully counterclockwise.
2. Connect the digital voltage meter to the speaker terminal. And set the digital voltage meter for the DC position.
3. Turn the mains switch ON. Put thin adjustment screw driver in to the hole of the HDAM (Q601:L ch / Q701:R ch) copper cover. Adjust variable resistors in the HDAM (Q601:L ch / Q701:R ch) value at $0\text{mV}\pm 3\text{mV}$ with in 10 seconds after speaker relay turn ON.

DC オフセット電圧調整

1. 本体の電源スイッチを入れるまえに、ボリュームを最小に、バランス及びトーンコントロールをセンターに合わせます。P601基板上のR627(L ch)及びP701基板上のR727(R ch)の半固定抵抗を反時計回りにしぼりきります。
2. 本体背面のスピーカー端子にデジタルボルトメータを接続します。(レンジはDCに設定する。)
3. HDAM(Q601:L ch/Q701:R ch)のカバーにあいた穴に調整用ドライバーをさし込み、中の半固定抵抗を回せるようにします。電源スイッチをオンにし、スピーカーリレーがオンになってから10秒以内に半固定抵抗を回しデジタルボルトメータの値が $0\text{mV}\pm 3\text{mV}$ になるように調整します。

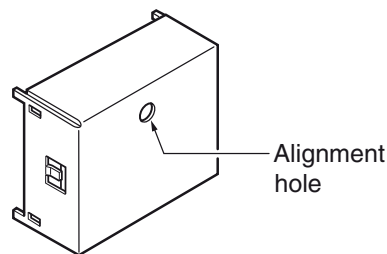

7. IDLING CURRENT ALIGNMENT

REMARK

Before "Idling current alignment", "**DC offset voltage alignment**" have to be done!!

1. Each of cement resistor R641(on the PCB P601:Lch) and cement resistor R741(on the PCB P701:Rch) are provided with three test points. Connect the digital voltage meter, set for the DC voltage input, to the test points at the two extremities of three test points of R641(L ch) and R741(R ch).
2. After the setup above, turn the mains switch ON and heat up the amplifier about 10 minutes.
3. Adjust variable resistors R627(on the PCB P601:L ch) and R727(on the PCB P701:R ch) according to the digital volt meter reading. The target setting value is $9\text{mV}\pm 1\text{mV}$ (45mA) for both L ch and R ch.

アイドルリング電流調整

【注意】

アイドルリング電流の調整は必ずDCオフセット電圧の調整を終えてから行って下さい。

1. P601基板上のセメント抵抗R641(L ch)及びP701基板上のセメント抵抗R741(R ch)の3本の測定用端子のうちの両端の2本にデジタルボルトメータを接続します。(レンジはDCに設定する。)
2. 電源スイッチをオンにし、アイドルリング電流が安定するまで、およそ10分間放置します。
3. P601基板上の半固定抵抗R627(L ch)とP701基板上の半固定抵抗R727(R ch)を時計回りにまわしデジタルボルトメータの値が $9\text{mV}\pm 1\text{mV}$ (45mA)になるように調整します。

Measurement point

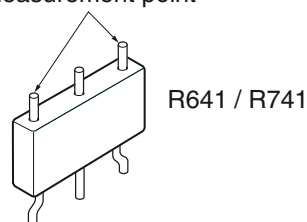

9. ELECTRICAL PARTS LIST

ASSIGNMENT OF COMMON PARTS CODES.

RESISTORS

R***: 1) GD05 × × × 140, Carbon film fixed resistor, ±5% 1/4W
 R***: 2) GD05 × × × 160, Carbon film fixed resistor, ±5% 1/6W

① — Resistance value

Examples ;

① Resistance value
 0.1 Ω 001 10 Ω 100 1 kΩ 102 100 kΩ 104
 0.5 Ω 005 18 Ω 180 2.7 kΩ 272 680 kΩ 684
 1 Ω 010 100 Ω 101 10 kΩ 103 1 MΩ 105
 6.8 Ω 068 390 Ω 391 22 kΩ 223 4.7 MΩ 475

Note : Please distinguish 1/4W from 1/6W by the shape of parts used actually.

CAPACITORS

C***: CERAMIC CAP.

3) DD1 × × × × 370, Ceramic capacitor
 Disc type
 Temp.coeff.P350 ~ N1000, 50V
 ② — Capacity value
 ③ — Tolerance

Examples ;

② Tolerance (Capacity deviation)
 ±0.25 pF 0
 ±0.5 pF 1
 ±5% 5

* Tolerance of COMMON PARTS handled here are as follows :

0.5 pF ~ 5 pF ±0.25 pF
 6 pF ~ 10 pF ±0.5 pF
 12 pF ~ 560 pF ±5%

③ Capacity value



0.5 pF 005 3 pF 030 100 pF 101
 1 pF 010 10 pF 100 220 pF 221
 1.5 pF 015 47 pF 470 560 pF 561

C*** : CERAMIC CAP.

4) DK16 × × × 300, High dielectric constant ceramic capacitor
 Disc type
 Temp.chara. 2B4, 50V
 ④ — Capacity value

Examples ;

④ Capacity value
 100 pF 101 1000 pF 102 10000 pF 103
 470 pF 471 2200 pF 222

C***: 5) ELECTROLY CAP. (), 6) FILM CAP. ()

5) EA × × × × × 10, Electrolytic capacitor
 One-way lead type, Tolerance ±20%
 ⑤ — Capacity value
 ⑥ — Working voltage

Examples ;

⑤ Capacity value
 0.1 μF 104 4.7 μF 475 100 μF 107
 0.33 μF 334 10 μF 106 330 μF 337
 1 μF 105 22 μF 226 1100 μF 118
 2200 μF 228

⑥ Working voltage

6.3V 006 25V 025
 10V 010 35V 035
 16V 016 50V 050

6) DF15 × × × 350 — Plastic film capacitor
 DF15 × × × 310 — One-way type, Mylar ±5% 50V
 DF16 × × × 310 — Plastic film capacitor
 One-way type, Mylar ±10% 50V
 ⑦ — Capacity value

Examples ;

⑦ Capacity value
 0.001 μF (1000 pF) 102 0.1 μF 104
 0.0018 μF 182 0.56 μF 564
 0.01 μF 103 1 μF 105
 0.015 μF 153

NOTE : 1) The above CODES (R*** , R*** , C*** , C*** and C***) are omitted on the schematic diagram in some case.
 2) On the occasion, be confirmed the common parts on the parts list.
 3) Refer to "Common Parts List" for the other common parts (R105, DD4, DK4).

NOTE ON SAFETY FOR FUSIBLE RESISTOR :

The suppliers and their type numbers of fusible resistors are as follows;

1. KOA Corporation

Part No. (MJL)	Type No. (KOA)	Description
NH05 × × × 140	RF25S × × × × ΩJ	(±5% 1/4W)
NH05 × × × 120	RF50S × × × × ΩJ	(±5% 1/2W)
NH85 × × × 110	RF73B2A × × × × ΩJ	(±5% 1/10W)
NH95 × × × 140	RF73B2E × × × × ΩJ	(±5% 1/4W)

* Resistance value * Resistance value
 (0.1 Ω – 10 kΩ)

2. Matsushita Electronic Components Co., Ltd

Part No. (MJL)	Type No. (MEC)	Description
NF05 × × × 140	ERD-2FCJ × × ×	(±5% 1/4W)
RF05 × × × 140		
NF02 × × × 140	ERD-2FCG × × ×	(±2% 1/4W)
RF02 × × × 140		

* Resistance value * Resistance value



Examples ;

* Resistance value
 0.1 Ω 001 10 Ω 100 1 kΩ 102 100 kΩ 104
 0.5 Ω 005 18 Ω 180 2.7 kΩ 272 680 kΩ 684
 1 Ω 010 100 Ω 101 10 kΩ 103 1 MΩ 105
 6.8 Ω 068 390 Ω 391 22 kΩ 223 4.7 MΩ 475

ABBREVIATION AND MARKS

ANT. : ANTENNA	BATT. : BATTERY
CAP. : CAPACITOR	CER. : CERAMIC
CONN. : CONNECTING	DIG. : DIGITAL
HP : HEADPHONE	MIC. : MICROPHONE
μ-PRO : MICROPROCESSOR	REC. : RECORDING
RES. : RESISTOR	SPK : SPEAKER
SW : SWITCH	TRANSF. : TRANSFORMER
TRIM. : TRIMMING	TRS. : TRANSISTOR
VAR. : VARIABLE	X'TAL : CRYSTAL

NOTE ON SAFETY :

Symbol  Fire or electrical shock hazard. Only original parts should be used to replaced any part marked with symbol  . Any other component substitution (other than original type), may increase risk of fire or electrical shock hazard.

安全上の注意 :

 がついている部品は、安全上重要な部品です。必ず指定されている部品番号の部品を使用して下さい。

POS. NO	VERS. COLOR	PART NO. (FOR PCS)	DESCRIPTION	PART NO. (MJI)
C151		9965 000 01560	P151-BTL BUFFER CIRCUIT BOARD	
C152		9965 000 01560	P151-CAPACITORS	
C153			FILM 270pF ±5% 100V OFC	OF55271540
C156		4822 124 81151	FILM 270pF ±5% 100V OFC	OF55271540
C157		4822 124 90051	ELECT. 22µF 25V ARA	OA22602550
C158		4822 124 90051	ELECT. 220µF M 25V ARA	OA22702550
C159		4822 122 40617	ELECT. 220µF M 25V ARA	OA22702550
C160		4822 122 30043	CER. 0.1µF +80%-20% DC50V	DD38104010
C161		4822 122 30043	CER. 0.01µF +80%-20% 50V	DK18103310
C166	/N,/S	9965 000 01344	FILM 100pF ±5% 100V APSV	OF15101540
R179		4822 052 10151	P151-RESISTORS	
R180		4822 052 10151	150Ω ±5% 1/6W	GG05151160
			150Ω ±5% 1/6W	GG05151160
R***			P151-RESISTORS (COMMON)	
			CARBON FILM FIXED RES.	
			±5% 1/6W : R151-R162	
			R167-R178 R181-R184	
D151		4822 130 32362	P151-MISCELLANEOUS	
			DIODE 1SS176 MA165 1SS254	HD20002000
			30V 0.1A	
Q151		4822 130 42949	TRS. 2SA970 GR OR BL	HT109702A0
Q152		4822 130 42949	TRS. 2SA970 GR OR BL	HT109702A0
Q153		4822 130 43233	TRS. 2SC2240 GR OR BL	HT322402A0
Q156		4822 130 42949	TRS. 2SA970 GR OR BL	HT109702A0
Q157		4822 130 42949	TRS. 2SA970 GR OR BL	HT109702A0
Q158		4822 209 16926	IC OPA2604AP BURR-BROWN	HC10008610
Q159				
J151		9965 000 00593	P151-MISCELLANEOUS	
J152		9965 000 00593	TERMINAL 2P RCA PIN JACK	YT02021390
J154		9965 000 00593	TERMINAL 2P RCA PIN JACK	YT02021390
L151		9965 000 01576	RELAY MR82-24USR	LY20240480
L152		9965 000 01576	RELAY MR82-24USR	LY20240480
S151		9965 000 01592	SLIDE SW. SSSU142-S09N-1	SS04020790
S152		9965 000 01582	SLIDE SW. SSSU12	SS02020950
C261		4822 122 40617	P261-METER & LAMP CIRCUIT BOARD	
M261		4822 344 14034	CER. 0.1µF +80%-20% DC50V	DD38104010
M262		4822 134 40925	D.C METER MG-28	IM11030030
			LAMP 8V 100mA DC IGN.BLUE	IN10080680
▲ R261		4822 116 82805	1Ω ±5% 1/6W	GG05010160
C601		9965 000 01560	P601-POWER AMP L CIRCUIT BOARD	
C602		4822 121 10867	P601-CAPACITORS	
C603		4822 124 90365	FILM 270pF ±5% 100V OFC	OF55271540
C604		4822 124 90365	FILM 0.1µF ±5% 100V OFC	OF55104540
C605		4822 124 90365	ELECT. 220µF M 25V RA-2	OA22702520
C607	/F,/U	9965 000 01561	ELECT. 220µF M 25V RA-2	OA22702520
C607	/K,/N,/S	9965 000 02015	MICA 10pF ±0.5pF 500V FE	DF31100520
C608		4822 124 12276	ELECT. 10µF M 100V RA-2	OA10610020
C610		4822 124 22273	ELECT. 22µF M 25V ARS	OA22602540
C611		9965 000 01562	FILM 0.01µF ±5% 100V PP	OF15103540
			ELECT. 0.47µF M 50V RA-2	OA47405020
			ELECT 10µF M 50V RA2BP	EQ10605090

POS. NO	VERS. COLOR	PART NO. (FOR PCS)	DESCRIPTION	PART NO. (MJI)
C612		9965 000 01562	ELECT 10µF M 50V RA2BP	EQ10605090
C613	/F,/U		ELECT. 330µF M 50V RA-2	OA33705020
C613	/K,/N,/S	9965 000 02014	ELECT. 220µF M 50V ARS	OA22705040
C614	/F,/U		ELECT. 330µF M 50V RA-2	OA33705020
C614	/K,/N,/S	9965 000 02014	ELECT. 220µF M 50V ARS	OA22705040
C615		9965 000 01564	FILM 680pF ±5% 100V OFC	OF55681540
R605		4822 111 20413	P601-RESISTORS	
▲ R607		4822 052 10102	220Ω ±1% 1/4W ERD	NR01221140
▲ R608		4822 052 10102	1kΩ ±5% 1/6W	GG05102160
▲ R609		4822 111 31001	1kΩ ±5% 1/6W	GG05102160
▲ R610		4822 111 31001	330Ω ±5% 1/6W	GG05331160
R613		4822 111 31001	330Ω ±5% 1/6W	GG05331160
R614		9965 000 01565	68Ω ±1% 1/4W ERD	NR01680140
R615		4822 111 20413	220Ω ±1% 1/4W ERD	NR01221140
R616		4822 111 20413	220Ω ±1% 1/4W ERD	NR01221140
R617		4822 050 23308	220Ω ±1% 1/4W ERD	NR01221140
R618		4822 050 23308	220Ω ±1% 1/4W ERD	NR01221140
R619		4822 050 23308	3.3MΩ ±5% 1/6W	GD05335160
R621		4822 050 23308	3.3MΩ ±5% 1/6W	GD05335160
▲ R621		4822 053 10681	680Ω ±5% 1W	GA05681010
R624				
R627		9965 000 01566	TRIM. VARIABLE 2.2kΩ	RA02220760
R628		4822 052 10109	10Ω ±5% 1/6W	GG05100160
R629		4822 052 10101	100Ω ±5% 1/6W	GG05101160
R630		4822 052 10101	100Ω ±5% 1/6W	GG05101160
▲ R631		4822 050 22209	22Ω ±5% 1/4W	GG05220140
▲ R632		4822 050 22209	22Ω ±5% 1/4W	GG05220140
R633		4822 052 10471	470Ω ±5% 1/6W	GG05471160
R634		4822 052 10471	470Ω ±5% 1/6W	GG05471160
R635		4822 050 26809	68Ω ±5% 1/6W	GG05680160
R636		4822 050 26809	68Ω ±5% 1/6W	GG05680160
▲ R637		4822 052 10151	150Ω ±5% 1/6W	GG05151160
R638			JUMPER WIRE 5MM	75060501P0
R639		4822 052 10109	10Ω ±5% 1/6W	GG05100160
R640		4822 052 10109	10Ω ±5% 1/6W	GG05100160
▲ R641		4822 111 91402	0.1Ω X2 3W	BZ10102010
R642		4822 052 10102	1kΩ ±5% 1/6W	GG05102160
R643		4822 052 10102	1kΩ ±5% 1/6W	GG05102160
R***			P601-RESISTORS (COMMON)	
			CARBON FILM FIXED RES.	
			±5% 1/6W : R601-R604 R611	
			R612 R620 R625 R626	
			R644-R647	
D601		4822 130 83385	P601-SEMICONDUCTORS	
D602		4822 130 83385	ZENER DIODE HZ20L-1	HD30020010
D603		4822 130 32362	ZENER DIODE HZ20L-1	HD30020010
D604		4822 130 80837	DIODE 1SS176 MA165 1SS254	HD20002000
D605			30V 0.1A	
▲ R261		4822 130 32362	DIODE HSS81TD 150V 150mA	HD20027010
D612		4822 130 32362	DIODE 1SS176 MA165 1SS254	HD20002000
D613		4822 130 33948	30V 0.1A	
D614		4822 130 33948	ZENER DIODE 5.6V	HD30561000
D615		4822 130 33948	ZENER DIODE 5.6V	HD30561000
D616		4822 130 80837	DIODE HSS81TD 150V 150mA	HD20027010
D617		4822 130 80837	DIODE HSS81TD 150V 150mA	HD20027010
D617		4822 130 80837	DIODE HSS81TD 150V 150mA	HD20027010
K601			TRS. KIT 2SA1837 & 2SC4793	HK183719C0
Q601			HFE SELECTED RANK	
Q602		4822 130 60526	IC NEW HDAM	KH313J1010
Q603		4822 130 42949	TRS. 2SD1508	HT415080A0
Q604		4822 130 43233	DARLINGTON TR.HFE>4000	
Q605		4822 130 42949	TRS. 2SA970 GR OR BL	HT109702A0
			TRS. 2SC2240 GR OR BL	HT322402A0
			TRS. 2SA970 GR OR BL	HT109702A0

POS. NO	VERS. COLOR	PART NO. (FOR PCS)	DESCRIPTION	PART NO. (MJI)	POS. NO	VERS. COLOR	PART NO. (FOR PCS)	DESCRIPTION	PART NO. (MJI)	
Q606		4822 130 43233	TRS. 2SC2240 GR OR BL	HT322402A0	R***			P701-RESISTORS (COMMON) CARBON FILM FIXED RES. ±5% 1/6W : R701-R704 R711 R712 R720 R725 R726 R744-R747		
Q607		4822 130 43283	TRS. 2SC2705 O OR Y	HT327052A0						
Q608		4822 130 42999	TRS. 2SA1145 O OR Y	HT111452A0						
Q609		4822 130 42999	TRS. 2SA1145 O OR Y	HT111452A0						
Q610		4822 130 43283	TRS. 2SC2705 O OR Y	HT327052A0						
Q611		4822 130 43283	TRS. 2SC2705 O OR Y	HT327052A0						
Q612		4822 130 42999	TRS. 2SA1145 O OR Y	HT111452A0						
▲ Q613		4822 130 63635	TRS. 2SC4793 O Y	HT347932A0		D701	4822 130 83385		ZENER DIODE HZ20L-1	HD30020010
▲ Q614		4822 130 63634	TRS. 2SA1837 O Y	HT118372A0		D702	4822 130 83385		ZENER DIODE HZ20L-1	HD30020010
▲ Q615		4822 130 60741	TRS. 2SC3284 O P Y 125W FMG112	HT332843D0		D703	4822 130 32362		DIODE 1SS176 MA165 1SS254 30V 0.1A	HD20002000
▲ Q616		4822 130 63674	TRS. 2SA1303 O P Y 125W FMG112	HT113033D0		D704	4822 130 80837		DIODE HSS81TD 150V 150MA	HD20027010
Q617		4822 130 43233	TRS. 2SC2240 GR OR BL	HT322402A0		D705	4822 130 32362		DIODE 1SS176 MA165 1SS254 30V 0.1A	HD20002000
Q618		4822 130 42949	TRS. 2SA970 GR OR BL	HT109702A0		D712	4822 130 32362		DIODE 1SS176 MA165 1SS254 30V 0.1A	HD20002000
			P701-POWER AMP R CIRCUIT BOARD			D713	4822 130 33948		ZENER DIODE 5.6V	HD30561000
			P701-CAPACITORS			D714	4822 130 33948		ZENER DIODE 5.6V	HD30561000
C701		9965 000 01560	FILM 270pF ±5% 100V OFC	OF55271540		D715	4822 130 80837		DIODE HSS81TD 150V 150mA	HD20027010
C702		4822 121 10867	FILM 0.1µF ±5% 100V OFC	OF55104540		D716	4822 130 80837		DIODE HSS81TD 150V 150mA	HD20027010
C703		4822 124 90365	ELECT. 220µF M 25V RA-2	OA22702520		D717	4822 130 80837		DIODE HSS81TD 150V 150mA	HD20027010
C704		4822 124 90365	ELECT. 220µF M 25V RA-2	OA22702520						
C705		9965 000 01561	MICA 10pF ±0.5pF 500V FE	DF31100520		K701			TRS. KIT 2SA1837 & 2SC4793 HFE SELECTED RANK	HK183719C0
C707	/F,/U		ELECT. 10µF M 100V RA-2	OA10610020		Q701			IC NEW HDAM	KH313J1010
C707	/K,/N,/S	9965 000 02015	ELECT. 22µF M 25V ARS	OA22602540		Q702	4822 130 60526		TRS. 2SD1508	HT415080A0
C708		4822 124 12276	FILM 0.01µF ±5% 100V PP	OF15103540		Q703	4822 130 42949		DARLINGTON TR.HFE>4000	HT109702A0
C710		4822 124 22273	ELECT. 0.47µF M 50V RA-2	OA47405020		Q704	4822 130 43233		TRS. 2SA970 GR OR BL	HT322402A0
C711		9965 000 01562	ELECT 10µF M 50V RA2BP	EQ10605090		Q705	4822 130 42949		TRS. 2SA970 GR OR BL	HT109702A0
C712		9965 000 01562	ELECT 10µF M 50V RA2BP	EQ10605090		Q706	4822 130 43233		TRS. 2SC2240 GR OR BL	HT322402A0
C713	/F,/U		ELECT. 330µF M 50V RA-2	OA33705020		Q707	4822 130 43283		TRS. 2SC2705 O OR Y	HT327052A0
C713	/K,/N,/S	9965 000 02014	ELECT. 220µF M 50V ARS	OA22705040		Q708	4822 130 42999		TRS. 2SA1145 O OR Y	HT111452A0
C714	/F,/U		ELECT. 330µF M 50V RA-2	OA33705020		Q709	4822 130 42999		TRS. 2SA1145 O OR Y	HT111452A0
C714	/K,/N,/S	9965 000 02014	ELECT. 220µF M 50V ARS	OA22705040		Q710	4822 130 43283		TRS. 2SC2705 O OR Y	HT327052A0
C715		9965 000 01564	FILM 680pF ±5% 100V OFC	OF55681540	Q711	4822 130 43283	TRS. 2SC2705 O OR Y	HT327052A0		
			P701-RESISTORS		Q712	4822 130 42999	TRS. 2SA1145 O OR Y	HT111452A0		
R705		4822 111 20413	220Ω ±1% 1/4W ERD	NR01221140	▲ Q713	4822 130 63635	TRS. 2SC4793 O Y	HT347932A0		
▲ R707		4822 052 10102	1kΩ ±5% 1/6W	GG05102160	▲ Q714	4822 130 63634	TRS. 2SA1837 O Y	HT118372A0		
▲ R708		4822 052 10102	1kΩ ±5% 1/6W	GG05102160	▲ Q715	4822 130 60741	TRS. 2SC3284 O P Y 125W FMG112	HT332843D0		
▲ R709		4822 111 31001	330Ω ±5% 1/6W	GG05331160	Q716	4822 130 63674	TRS. 1 2SA1303 O P Y 125W FMG112	HT113033D0		
▲ R710		4822 111 31001	330Ω ±5% 1/6W	GG05331160						
R713		9965 000 01565	68Ω ±1% 1/4W ERD	NR01680140	Q717	4822 130 43233	TRS. 2SC2240 GR OR BL	HT322402A0		
R714		4822 111 20413	220Ω ±1% 1/4W ERD	NR01221140	Q718	4822 130 42949	TRS. 2SA970 GR OR BL	HT109702A0		
R715		4822 111 20413	220Ω ±1% 1/4W ERD	NR01221140						
R716		4822 111 20413	220Ω ±1% 1/4W ERD	NR01221140						
R717		4822 050 23308	3.3MΩ ±5% 1/6W	GD05335160						
R718		4822 050 23308	3.3MΩ ±5% 1/6W	GD05335160						
R719		4822 050 23308	3.3MΩ ±5% 1/6W	GD05335160	C801	9965 000 01577	ELECT 1800µF 50V FOR AUDIO	EB18805020		
R721					C802	9965 000 01577	ELECT 1800µF 50V FOR AUDIO	EB18805020		
R724		4822 053 10681	680Ω ±5% 1W	GA05681010						
R727		9965 000 01566	TRIM. VARIABLE 2.2kΩ	RA02220760	C805	4822 124 90355	ELECT. 100µF M 50V RA-2	OA10705020		
R728		4822 052 10109	10Ω ±5% 1/6W	GG05100160	C806	4822 124 90355	ELECT. 100µF M 50V RA-2	OA10705020		
R729		4822 052 10101	100Ω ±5% 1/6W	GG05101160	C807	4822 124 90366	ELECT. 220µF M 50V RA-2	OA22705020		
R730		4822 052 10101	100Ω ±5% 1/6W	GG05101160	C808	4822 124 90366	ELECT. 220µF M 50V RA-2	OA22705020		
▲ R731		4822 050 22209	22Ω ±5% 1/4W	GG05220140	C809	4822 124 41542	ELECT. 470µF M 50V RA-2	OA47705020		
▲ R732		4822 050 22209	22Ω ±5% 1/4W	GG05220140	C810	4822 124 41535	ELECT. 100µF M 25V RA-2	OA10702520		
R733		4822 052 10471	470Ω ±5% 1/6W	GG05471160	C811	4822 124 90366	ELECT. 220µF M 50V RA-2	OA22705020		
R734		4822 052 10471	470Ω ±5% 1/6W	GG05471160	C815	4822 124 41543	ELECT. 1µF M 50V RA-2	OA10505020		
R735		4822 050 26809	68Ω ±5% 1/6W	GG05680160	C816	4822 124 12276	FILM 0.01µF ±5% 100V PP	OF15103540		
R736		4822 050 26809	68Ω ±5% 1/6W	GG05680160	C901	4822 124 12276	FILM 0.01µF ±5% 100V PP	OF15103540		
▲ R737		4822 052 10151	150Ω ±5% 1/6W	GG05151160	C902	4822 124 22698	ELECT. 47µF M 25V RA-2	OA47602520		
R738			JUMPER WIRE 5MM	75060501P0	C903	4822 122 40617	CER. 50V DC 0.1µF +80 -20%	DB38104010		
R739		4822 052 10109	10Ω ±5% 1/6W	GG05100160	C904	5322 124 21731	ELECT. 10µF M 50V RA-2	OA10605020		
R740		4822 052 10109	10Ω ±5% 1/6W	GG05100160	C905	4822 124 22698	ELECT. 47µF M 25V RA-2	OA47602520		
▲ R741		4822 111 91402	0.1Ω X 2 3W	BZ10102010	C906	4822 124 22273	ELECT. 0.47µF M 50V RA-2	OA47405020		
R742		4822 052 10102	1kΩ ±5% 1/6W	GG05102160	C907	9965 000 01575	FILM 0.039µF ±5% 100V OFC	OF55393540		
R743		4822 052 10102	1kΩ ±5% 1/6W	GG05102160	C908	9965 000 01575	FILM 0.039µF ±5% 100V OFC	OF55393540		
					C909	4822 124 12276	FILM 0.01µF ±5% 100V PP	OF15103540		

POS. NO	VERS. COLOR	PART NO. (FOR PCS)	DESCRIPTION	PART NO. (MJI)
C910	/N,S	4822 124 12276	FILM 0.01μF ±5% 100V PP	OF15103540
C951		4822 122 40617	CER. 50V DC 0.1μF +80 -20%	DD38104010
C952		4822 124 41543	ELECT. 1μF M 50V	OA10505020
C953		4822 124 41535	ELECT. 100μF M 25V RA-2	OA10702520
P801-RESISTORS				
▲ R801		4822 050 21108	1Ω ±5% 1/2W	GG05010120
▲ R802		4822 050 21108	1Ω ±5% 1/2W	GG05010120
▲ R803		4822 052 10101	100Ω ±5% 1/6W	GG05101160
▲ R804		4822 052 10101	100Ω ±5% 1/6W	GG05101160
▲ R807		4822 050 24708	4.7Ω ±5% 1/4W	GG05047140
▲ R808		4822 050 24708	4.7Ω ±5% 1/4W	GG05047140
▲ R809		4822 117 10158	1Ω ±5% 1/4W	GG05010140
▲ R810		4822 052 10101	100Ω ±5% 1/6W	GG05101160
▲ R812		4822 050 24708	4.7Ω ±5% 1/4W	GG05047140
▲ R814		4822 113 90119	FUSE 22Ω ±2% 1/4W	NF02220140
▲ R816		4822 052 10478	4.7Ω ±5% 1/6W	GG05047160
R913		4822 053 10109	10Ω ±5% 1W	GA05100010
R914		4822 053 10109	10Ω ±5% 1W	GA05100010
R917		4822 053 10331	330Ω ±5% 1W	GA05331010
R918		4822 053 10331	330Ω ±5% 1W	GA05331010
R951		4822 052 10109	10Ω ±5% 1/6W	GG05100160
R955		4822 130 32362	DIODE 1SS176 MA165 1SS254 30V 0.1A	HD20002000
P801-RESISTORS (COMMON)				
CARBON FILM FIXED RES. ±5% 1/6W : R805 R806 R811 R815 R817 R901-R912 R952-R959				
P801-SEMICONDUCTORS				
▲ D801		4822 130 80839	DIODE S5688G	HD20029050
▲ D808			VRM=400V IO=1A	
D809		4822 130 10851	ZENER DIODE HZ24-2L	HD30012010
D810		4822 130 10851	ZENER DIODE HZ24-2L	HD30012010
D811		4822 130 80839	DIODE S5688G	HD20029050
			VRM=400V IO=1A	
D812		4822 130 80839	DIODE S5688G	HD20029050
			VRM=400V IO=1A	
▲ D813		4822 130 80839	DIODE S5688G	HD20029050
			VRM=400V IO=1A	
▲ D814		4822 130 80839	DIODE S5688G	HD20029050
			VRM=400V IO=1A	
D815		4822 130 80116	ZENER DIODE 24V	HD32401000
▲ D819		4822 130 80839	DIODE S5688G	HD20029050
			VRM=400V IO=1A	
▲ D820		4822 130 80839	DIODE S5688G	HD20029050
			VRM=400V IO=1A	
D901		4822 130 80837	DIODE HSS81TD 150V 150mA	HD20027010
D951		4822 130 32362	DIODE 1SS176 MA165 1SS254 30V 0.1A	HD20002000
D952		4822 130 33948	ZENER DIODE 5.6V	HD30561000
▲ Q801		4822 130 11605	TRS. 2SD1415	HT41415100
▲ Q802		4822 130 11604	TRS. 2SB1020	HT21020100
Q803		4822 130 42836	F.E.T. 2SK246 GR	HF202461C0
Q804		4822 130 42836	F.E.T. 2SK246 GR	HF202461C0
▲ Q805		4822 130 11605	TRS. 2SD1415	HT41415100
Q806		4822 130 42836	F.E.T. 2SK246 GR	HF202461C0
Q901		4822 209 83312	IC TA7317P	HC10042050
Q951		4822 130 42836	F.E.T. 2SK246 GR	HF202461C0
Q952		4822 130 43233	TRS. 2SC2240 GR OR BL	HT322402A0
Q953		4822 130 43233	TRS. 2SC2240 GR OR BL	HT322402A0
Q954		4822 130 60117	TRS. 2SC3419 Y	HT334191Y0
Q955		4822 209 83679	40V 0.8A PC=1.2W 5W IC DUAL OP-AMP NJM2904	HC10030090

POS. NO	VERS. COLOR	PART NO. (FOR PCS)	DESCRIPTION	PART NO. (MJI)
▲ G801		4822 121 20263	P801-MISCELLANEOUS CAP.COMP. 0.47μF + 6.8Ω NOISE KILLER	BF47400010
L801		4822 158 60605	FERRIT BEADS B-01-RT	FC90050060
L901		4822 280 70354	RELAY VB 24MBU-510 5A/240VAC	LY20240310
L905		4822 158 60605	FERRIT BEADS B-01-RT	FC90050060
U804		4822 158 60605	FERRITE BEADS B-01-RT	FC90050060
▲ P861			P861-RECTIFIER CIRCUIT BOARD	WA314J1050
▲ D861		9965 000 01578	DIODE D25XB60 600V 25A BRIDGE-DI	HE20029290
▲ G861		4822 121 20263	CAP.COMP. 0.47μF + 6.8Ω NOISE KILLER	BF47400010
P871-ACOUTLET CIRCUIT BOARD [/F, /U VERSION]				
▲ J871	/F, /U		JACK MAINS OUTLET CCT1306-0212	YJ04001840
P891-POWER SW CIRCUIT BOARD				
▲ C891		4822 121 43732	FILM 0.01μF 250V AC	DF77103500
▲ S891		4822 276 12647	PUSH SW. ESB-99753V-4 TV-8	SP01011470
PM01-HDAM CIRCUIT BOARD FOR Q601 Q701 PM01-RESISTOR				
RM09		4822 100 20681	TRIM. 2.2kΩ RH0638CJ3R	RA02220780
PM01-RESISTORS (COMMON) CARBON FILM FIXED RES. ±5% 1/6W : RM01-RM08				
DM01		4822 130 32362	DIODE 1SS176 MA165 1SS254 30V 0.1A	HD20002000
DM05				
QM01		5322 130 41844	F.E.T. 2SK170 BL VGDS=-40V PD=0.4V	HF201701G0
QM02		5322 130 41844	F.E.T. 2SK170 BL VGDS=-40V PD=0.4V	HF201701G0
QM03		4822 130 43233	TRS. 2SC2240 GR OR BL	HT322402A0
QM04		4822 130 42949	TRS. 2SA970 GR OR BL	HT109702A0
QM05		4822 130 42949	TRS. 2SA970 GR OR BL	HT109702A0
QM06		4822 130 43233	TRS. 2SC2240 GR OR BL	HT322402A0